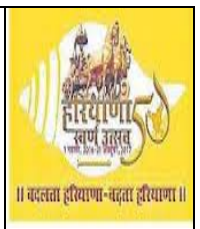

**RAJIV GANDHI THERMAL POWER PLANT, KHEDAR, HISAR**

[Regd. Office – C-7, Urja Bhawan, Sector – 6, Panchkula]
 (A UNIT OF HARYANA POWER GENERATION CORPORATION LIMITED)
 (An ISO: 9001, ISO: 14001, OHSAS: 18001 Company)
PHONE: 01693-250565, FAX: 01693-250565/250454
Email: mm1.rgtpg@hpgcl.org.in Website: www.hpgcl.org.in
 Corporate Identity Number: U45207HR1997SGC03351

**NOTICE INVITING E-TENDER****NIT No.: 524/RGTPP/MM-I/TOE-13120****Dated: 10.06.2024**

Chief Engineer/RGTPP, HPGCL, Khedar, Hisar invites online Tenders in Two Parts from the manufacturers & their authorized dealers/suppliers for supply of **Idlers and Self aligned Brackets on annual rate contract basis.**

Sr. No.	Description	Tender Fee (Rs.) (Non – refundable)	EMD (Rs.)	E-service Fees (Rs.) (Non – refundable)	Last date of Downloading of Tender Documents , Bid Preparation & Bid Submission
1	Item details as per Annexure-1	1,180/-	1,71,600/-	1,180/-	08.07.2024 up to 15:00 hrs

1) (a) Pre Qualifying Requirements (PQRs) / Eligibility Criteria for the bidders:

The tender documents of only those bidders shall be considered who fulfill the following eligibility criteria and furnish duly signed/stamped documentary evidences along with the Part-I of tender in support of the same. The bidder shall furnish documentary evidence for the following:-

The bidder shall furnish documentary evidence for the following:-

- (I) The bidder must have experience of having successfully executed purchase orders for supplying of same/similar items in HPGCL/NTPC/State Electricity Board/Public Sector undertaking/any Corporation/State Government Undertaking/Semi Govt. Undertaking or any Thermal/Hydel Plant during last 7-years ending May 2024 having minimum order value as under:
 - Single order of the value not less than Rs. 68.63 Lacs OR
 - Two orders of the value not less than Rs. 42.89 Lacs OR
 - Three orders of the value not less than Rs. 34.31 Lacs.
- (II) The bidder to certify having its own testing facilities or the same has to be carried out at any Govt. Approved test lab.
- (III) The average annual turnover of the bidder during last three preceding years i.e. 2021-22, 2022-23 and 2023-24 should not be less than Rs. 85.79 lacs.

Note:-

1. In case where audited results for the last preceding financial year are not available for determining the average annual turnover, certificate of financial statements from a practicing chartered accountant shall be considered acceptable.
2. The firm should fill statement to bidders as per annexure-2 of General Terms & Conditions and submit authentic supporting documents for proving its credential. Original documents may be asked for verification at the time of finalizing the tender.

(b) Non-blacklisting Certificate:

Tenderer shall submit a certificate to the effect that “the tenderer is not black listed from any Public Sector undertakings of Central Govt./State Govt./SEBs/Corporations/any other reputed thermal plant.”

Criterion for Evaluation of Blacklisting: The firms who have been blacklisted by HPGCL or any other Centre or State Power Utility/Board or Corporation/or any other Thermal/Hydro Elect. Project shall not be eligible to bid against the NIT of HPGCL, however:

- (i) In case the blacklisting of the firm is for a specific plant and not for the organization as a whole then such blacklisting will not tantamount to ineligibility of the bidder.
- (ii) Blacklisting of the firm by any Unit of HPGCL shall be considered as ineligibility of the firm at any other project of HPGCL.
- (iii) In case any firm was blacklisted for a limited period in past by any organization and presently such blacklisting has removed by such organization then it will not tantamount to ineligibility of the bidder.
- (iv) Firm has to certify itself for its eligibility with supporting documents to participate in the NIT stating that it has not been blacklisted by any organization presently, however in case at a later stage if such certification is found wrong then it will lead to misrepresentation of facts and the firm shall be treated as blacklisted on this ground and action shall be taken as per regulation 36 and 37.

Decision of the HPGCL regarding fulfillment of pre qualification requirement shall be final and binding upon the bidders.

The Bidders can download the tender documents from the Portal: <https://etenders.hry.nic.in>.

(IV) Pre-requisites for online bidding:

In order to bid online on the portal <https://etenders.hry.nic.in> , the user machine must be updated with the latest Java. The link for downloading latest java applet is available on the Home page of the e-tendering Portal.

(V) Online Viewing of detailed Notice Inviting Tenders:-

The bidder can view the detailed NIT and the time schedule (Key Dates) for all the tenders floated through the single portal e-procurement system on the home Page at <https://etenders.hry.nic.in>.

(VI) Bid Preparation (Technical & Financial) Online Payment of Tender Document Fee, e-Service fee, EMD fees and Submission of Bid Seal of online Bids:

i) The Bidders shall have to pay for the **Tender documents Fees (Rs. 1180/-), EMD Fees (1,71,600/-) & e-Service Fee (Rs. 1180/-) online** by using the service of secure electronic payment gateway. The secure electronic payments gateway is an online interface between contractors and online payment authorization networks. The Payment for Tender Document Fee and eService Fee can be made by eligible bidders online directly through Debit Cards & Internet Banking Accounts and the payment for EMD can be made online directly through RTGS / NEFT. For online payments guidelines, Home Page of e-tendering portal <https://etenders.hry.nic.in> may be referred.

ii) Tender Fees and EMD Exemption Criteria:-

The following are exempted from depositing the earnest money:-

- a) **Public sector undertakings of the central/Haryana State Government .**
 - b) **Firms borne on D.G.S. &D/DS&D Haryana rate contracts.**
 - c) **Firms registered with the director of industries, Haryana or registered with National Small industries Corporation, Govt. Of India (NSIC). The exemption shall be for the specified items which are available on Director of Industries/NSIC Rate contracts.**
 - d) **Firms borne on the HPGCL's approved list of suppliers who have deposited permanent security of Rs. 10,00,000/- in cash/Bank Draft only with CE/RGTPP, Khedar, Hisar are exempted from deposit of earnest money. However they are required to super-scribed the Registration number given by respective project/office of HPGCL in their tender papers.**
 - e) **Only Haryana based Micro, Small & Medium industrial Enterprises as extended by Haryana Govt. in O/o No.: 2/2/2016-4IBII (1) Dated: 20.10.2016 as per Annexure attached.**
 - f) **Tender fees is exempted for only Haryana based Micro, Small & Medium industrial Enterprises manufacturer only as extended by Haryana Govt. in O/o No.: 2/2/2016-4IBII (1) Dated: 20.10.2016 as per Annexure attached.**
 - g) **No relaxation will be allowed to firms for exemption in Tender Fees and EMD fees other than firms detailed above. All firms are requested to deposit E-service Fees, Tender Fees and EMD fees online failing which tender shall liable to be rejected.**
- h) In cases where tenders are received in two parts, the bidder shall upload their technical offer containing documents, qualifying criteria, technical specifications, schedule of deliveries and all other terms and conditions except the rates (Price-Bid) in the part-I (Technical envelope). The price bid shall be submitted in separate part-II format supplied by purchasing authority online. The committee members shall open only part-I on scheduled date of opening of Technical bid. As per system settings, Part-II can't be opened on that date.
- i) The tenders shall be opened on the due date by tender opening committee comprising Executive Engineer and Sr. A.O. The tender documents shall be downloaded and print outs taken.
- j) The EMD of the successful tenderers will be adjusted against security deposit in the event of placement of order. EMD of unsuccessful tenderers will be refunded on finalization of contract.
- k) No interest shall be payable on Earnest Money Deposit.
- l) HPGCL reserves the right to forfeit Earnest Money Deposit or part thereof in circumstances which may indicate that the tenderer is not earnest in executing the contract. EMD shall also be forfeited in case the bidder does not come forward for execution of the contract agreements and submission of balance security deposit.
- m) If the tenderer withdraws his tender at any stage during the currency of his validity period, the EMD shall be forfeited in full in such cases.

(VII) **Key Dates:-**

The Tenderer can submit their tender documents (Online) as per the dates mentioned in the following Format:-

Sr. No.	Department Stage	Tenderer's Stage	Start date and time	Expiry date and time
1	-	Downloading of Tender Documents & Bid Preparation	10.06.2024 16:00 hrs	08.07.2024 up to 15:00 hrs
2	Technical Opening (Part-I)	-	11.07.2024 at 15:30 hrs.	
3	Short listing/Qualifying of Technical bids & Opening of Financial Bid		Will be intimated to the firms on their e-mail	

The bidders are strictly advised to follow dates and times as indicated in the online Notice Inviting Tenders. The date and time shall be binding on all bidders. All online activities are time tracked and the system enforces time locks that ensure that no activity or transaction can take place outside the start and end dates and the time of the stage as defined in the online Notice Inviting Tenders.

If bidder fails to complete the Online Bid Submission stage on the stipulated date and time, his/hers bid will be considered as bid not submitted, and hence not appear during tender opening stage.

- (VIII) If the Tenders are cancelled or recalled on any grounds, the Tender Documents fees and e-service fees will not be refunded to the firm. However, EMD shall be refunded.
- (IX) Unless exempted specially, tenders not accompanied with the prescribed EMD/ Cost of Tender shall be rejected. EMD/ Cost of Tender shall be in the prescribed mode of payment as asked in the NIT, otherwise, the tender shall be liable to be rejected.
- (X) The bidders shall ensure that payment shall be made at least 2 days prior to last date of submission of the bid.
- (XI) The bidder can revise his price-bid any number of times but only before last date of submission of bid. All previous quotes are deleted and only the latest price quoted is visible to the purchasing authority on the date of opening of price-bid.
- (XII) Material offered should be strictly according to the specifications. Unless a deviation from the specifications is pointed out by the tenderer specifically, it will be presumed that offer/tender conforms to the specifications.
- (XIII) The validity of the tender/offer shall be for 120 days from the date of opening of the price bid.**
- (XIV) The rate negotiations could be held up to L3 bidder, if the difference between the L1 quoted rates and those quoted by L2 and L3 is within 5% of the L1 quoted rates. In case where the L1 bidder refuses to further reduce his offered price and the L2 or L3 bidders come forward to offer a price which is better than the price offered by L1 bidder, the bidder whose price is accepted becomes L1 bidder. However, in such a situation, the original L1 bidder shall be given one more opportunity to match the discounted price. In case of acceptance, he would be treated as L1 bidder.
- (XV) The rates shall be quoted by the tenderer, item wise with price break-up on FOR destination basis in the format supplied by the purchaser. No deviation in terms shall be allowed.
- (XVI) The bidders / suppliers shall observe the highest standard of ethics during the submission of tender, procurement and execution of the contract. In case of evidence of cartel formation by the bidder(s), EMD is liable to be forfeited.
- (XVII) The bidder shall bear all costs including the bank charges, if any, associated with the preparation and submission of his bid, and the purchaser will in no case be responsible or liable for those costs, regardless of the conduct or outcome of the bidding process.
- (XVIII) Purchaser reserves the right to cancel the NIT or to change qualifying requirement or to reject any or all the tenders so received without assigning any reason.

(XIX) Preliminary information for bidders:

a) Registration of bidders on e Procurement Portal:-

All the bidders intending to participate in the tenders processed online are required to get registered on the centralized e-Procurement Portal i.e. <https://etenders.hry.nic.in>. Please visit the website for more details.

b) Obtaining a Digital Certificate:

- i) The Bids submitted online should be encrypted and signed electronically with a Digital Certificate to establish the identity of the bidder bidding online. These Digital Certificates are issued by an Approved Certifying Authority, by the Controller of Certifying Authorities, Government of India.

- ii) A Digital Certificate is issued upon receipt of mandatory identity (i.e. Applicant's PAN Card) and Address proofs and verification form duly attested by the Bank Manager / Post Master / Gazetted Officer. Only upon the receipt of the required documents, a digital certificate can be issued. For more details please visit the website – <https://etenders.hry.nic.in>.
- iii) The bidders may obtain Class-II or III digital signature certificate from any Certifying Authority or Sub-certifying Authority authorized by the Controller of Certifying Authorities. The bidder may obtain information **for support related to Haryana Tenders in addition to helpdesk you may also contact on email ID - eproc.nichry@yahoo.com , Tel- 0172-2700275**
Help Desk: 0120-4200462, 0120-4001002,
Mobile-8826246593
- iv) Bid for a particular tender must be submitted online using the digital certificate (Encryption & Signing), which is used to encrypt the data and sign the hash during the stage of bid preparation & hash submission. In case, during the process of a particular tender, the user loses his digital certificate (due to virus attack, hardware problem, operating system or any other problem) he will not be able to submit the bid online. Hence, the users are advised **to keep a backup of the certificate** and also keep the copies at safe place under proper security (for its use in case of emergencies).
- v) In case of online tendering, if the digital certificate issued to the authorized user of a firm is used for signing and submitting a bid, it will be considered equivalent to a no-objection certificate/power of attorney /lawful authorization to that User. The firm has to authorize a specific individual through an authorization certificate signed by all partners to use the digital certificate as per Indian Information Technology Act 2000. Unless the certificates are revoked, it will be assumed to represent adequate authority of the user to bid on behalf of the firm in the department tenders as per Information Technology Act 2000. The digital signature of this authorized user will be binding on the firm.
- vi) In case of any change in the authorization, it shall be the responsibility of management / partners of the firm to inform the certifying authority about the change and to obtain the digital signatures of the new person / user on behalf of the firm / company. The procedure for application of a digital certificate however will remain the same for the new user.
- vii) The same procedure holds true for the authorized users in a private/Public limited company. In this case, the authorization certificate will have to be signed by the directors of the company.
- viii) Bidders participating in online tenders shall check the validity of his/her Digital Signature Certificate before participating in the online Tenders at the portal <https://etenders.hry.nic.in>.
- ix) For help manual please refer to the 'Home Page' of the e-Procurement website at <https://etenders.hry.nic.in>, and click on the available link 'System Requirement" to download the file.
- x) Before submitting tenders all the instructions may be read carefully regarding submission of tenders. If any bidder finds discrepancies or omission in the tender documents or is in doubt as to the true meaning of any part, he shall clarify the same from tender issuing office in writing before the due date of submission of the bid.

(XX) Conditions of the contract and other information can be had from the office of XEN/MM-I (E-mail: mm1.rgtpp@hpgcl.org.in , Tel. No. 01693-250565, 9355084358) on any working day prior to last date of downloading of tender documents & bid preparation. Before submitting tenders the instructions may be read carefully regarding submission of tender. If any bidder finds discrepancies or omissions in the tender documents or is in doubt as to the true meaning of any part, he shall clarify same from tender issuing office in writing before due date and time of submission of bid.

(XXI) The tenderer shall quote the prices in English language and international numerals. The rates shall be in whole rupees and shall be entered in figures. For the purpose of tender, the metric system of units shall be used. The tenderers will quote their rates strictly as per details of material specifications.

(XXII) If the tenderer deliberately gives wrong information in his tender, HPGCL reserves the right to reject such tender at any stage.

(XXIII) All tenders received against open tender enquiry irrespective of whether they are from the approved suppliers on the registered list or others, shall be considered, provided they are on the prescribed e-tendering process mentioned above.

(XXIV) No provision for price escalation is made on any account. The price quoted by the tenderer shall be **FIRM** till the contract is completed. The tenderer acceptance of this condition should be indicated along with the Bid. Rates shall be quoted by the tenderer item wise with price breakup on FOR destination basis. Ordinarily the deviation in terms shall not be considered.

(XXV) Normally the tenders should not differ from the Terms & Conditions and technical specifications incorporated in the Tender Documents. In case of any deviation the same shall be specifically mentioned on separate sheet otherwise it will be presumed that tenderer agreed all terms & conditions as per Tender Document.

(XXVI) Opening of Tender:-

The tenders will be opened in the office of XEN/MM-II, RGTPP, HPGCL, Khedar, Hisar in the presence of authorized representative of the tenderer, if they so desire, at the time and date set for opening of tenders or in case any extension was given thereto on the extended tender opening date and time. Tenderer authorized representatives (up to two persons) may attend the opening.

The Price Bid (Part-II of the tender) shall be opened after Part-I of the tenders have been scrutinized and evaluated. The tenderer whose Part I have been approved, will be allowed to participate in opening of Price Bid (Part-II). The due date and time for opening of Price Bid (Part-II) shall be informed later on through mail.

Executive Engineer/MM-I
for Chief Engineer, RGTPP
HPGCL, Khedar, Hisar

(Referred to in regulation 7)
GENERAL TERMS AND CONDITIONS OF CONTRACT (Supply order)

1) Definitions:-

In the contract (as defined below) unless the context requires otherwise the words and expressions defined below shall have the meaning hereinafter assigned to them.

- a) The 'Purchaser' shall mean the HPGCL and shall include its successors in office and assigns.
- b) The 'Supplier /Manufacturer' shall mean M/s. _____ and shall include the Supplier's legal representatives, successors, and assigns.
- c) 'Material' shall mean and include the material to be supplied by the Supplier under the contract as per contract.
- d) 'Specifications' shall mean & include the specifications as detailed in Annexure attached herewith and drawings attached thereto as well as samples and patterns, (if any).
- e) 'Drawing' shall mean the drawing /drawings annexed to the specification (if any) or as approved by the purchaser.
- f) The 'Site' shall mean and include lands & buildings over / under upon where the materials are to be installed and used in accordance with terms & conditions.
- g) 'Place of delivery' shall mean the place of delivery at which the Supplier is responsible to deliver the materials at the specified contract price.
- h) The terms 'F.A.S', 'F.O.R', 'F.O.B.', 'C.I.F.' and other shipping dispatch terms as used herein shall have meaning in accordance with their usage in India.
- i) 'Work' shall mean and include supply of all materials, plants and equipments and rendering of other services by the supplier under this contract
- j) 'Consignee' shall mean the officer to whom the material is required to be despatched or the person specified in the purchase order.
- k) 'Contract' shall mean the Notice Inviting the Tender, Tender Form, and conditions of contract with their annexure and Purchase Order / Acceptance of offer / tender/LOI/LOA.
-'Purchasing Authority' shall mean the officer signing the acceptance of tender and shall include any officer who has authority to execute the relevant contract on behalf of the Purchaser.
- l) 'Purchase Order' shall mean an order of supply of material including the acceptance of the tender.
- m) 'Annexure' shall mean the Annexure to the terms & conditions.
- n) 'Test' shall mean such test as is prescribed by the ISI or by the HPGCL and / or considered necessary by the authorized agent of the Purchaser whether conducted / performed or made by him or any other agency acting under his direction.
- o) 'Delivery' shall be deemed to take place on delivery of material in accordance with terms of the Contract after test and inspection by the Purchaser or his authorized agent, to the consignee. If the rates are ex-works, date of dispatch/Goods Receipt (GR) and in case the rates are FOR destination, date of receipt of material in store in good conditions shall be treated as date of delivery.
- p) 'Inspecting Agency' means the agencies nominated and authorized by the competent authority for inspecting the material at the works of the supplier or at the designated place of inspection prescribed by the purchasing authority.
- q) 'Inspecting Officer' means, officer of the Corporation appointed by the Chief Engineer or the purchasing authority for inspection.
- r) 'Contract Value' shall mean the bare value of the goods 'ex-works price' without taking into account taxes, duties or any other incidental charges where the price is ex-works, but where the prices given in the PO are on FOR destination basis inclusive or exclusive of GST etc., the 'Contract value' would mean FOR destination prices, given in the PO inclusive of GST, other statutory levies etc. as the case may be.
- s) 'Total Contract Value' shall mean contract value plus statutory dues like GST etc. and any other amount payable under contract.

2) PARTIES:

The parties to the Contract are the Supplier and the Purchaser, Legal address of the Parties to the Contract is as under:

Supplier: M/s. _____ on which P.O. is placed.

Purchaser: RGTPP, Haryana Power Generation Corporation Ltd.

For all purposes of the contract, including the arbitration there under, the address of the Supplier mentioned above, shall be the address to which all communications addressed to the supplier shall be sent, unless the supplier has specifically intimated a change thereof.

3) AUTHORITY OF THE PERSON SIGNING THE CONTRACT ON BEHALF OF THE SUPPLIER:-

It is presumed that the person who has signed these Tender-papers (including the terms and conditions) has got authority to sign on behalf of the supplier. If it is discovered at any time that the person so signing had no authority to do so, the purchaser without prejudice to any other right or remedy available to him, may cancel the contract and make a purchase of the material at the risk and cost of such person and hold such person liable to the purchaser for all costs and damages arising from the cancellation of the contract including any loss which the purchaser may sustain on account of such purchase.

4) PRICES:

(i) Item wise prices with price breakup (i.e. cost price, freight, taxes and duties separately) shall be quoted by the bidders on FOR destination basis and shall remain FIRM during the currency of contract unless otherwise agreed. No deviation in terms should be allowed. However if not provided separately, then loading of Packing & Forwarding, Freight and Insurance shall be done, for comparison purpose, as under:

(a) Packing & Forwarding : @ 0.5% of the basic rate.

(b) Freight : @ 4 % of the basic rate or the railway freight on the basis of published goods tariff of Indian Railways or Freight on the basis of publication/certification of some approved transporter in case of any other mode of transport declared in the NIT, **whichever is higher.**

(c) Transit Insurance : @ 0.25% of basic rate.

(ii) GST, if charged, separately shall be paid as per actual within delivery period on production of following certificates:

a) Certified that transaction on which tax has been claimed will be included in the return to be submitted to the GST authorities for the assessment of GST and the amount claimed from HPGCL shall be paid to the GST authorities.

b) Certified that the goods on which GST has been charged have not been exempted from GST under Haryana / Central GST Act or rules made there under. The charge on account of the GST on these goods is correct under the provisions of the relevant act or rules made there under.

c) Certified that we shall indemnify to HPGCL in case it is found at a later stage that incorrect payment has been recovered on account of GST by us.

d) Certified that we are registered as dealer and our Haryana / Central GST No. is _____

*Our GST No. is Dt.

Note:- Any increase in taxes and duties after the delivery period shall be on supplier's account and shall not be borne by HPGCL (The above note shall not be applicable in case supplier is a Gov./Semi Govt./PSU).

(iii) ESCALATION/PRICE VARIATION CLAUSE.

No escalation shall be permitted in respect of any increase not arising out of the operation of any law and statutory or mandatory order of the Govt. of India or the concerned State Govt. In case the period of the purchase order for completion of supplies is more than one year and tenderer wishes to include an escalation clause in his quotation then bidder should provide full details of the escalation formula and bring out precisely the actual increase in the price of the finished item for every rupee worth of increase in each item of raw material/component of wages, to which the escalation applies. The tenderer shall furnish such documentary evidence, as may be required by the HPGCL, in support of the increase in respect of each item of raw material/component of wages etc. for which the escalation is claimed. No escalation/price variation shall be considered beyond the scheduled delivery period. However, for valuation of L1 bidder the total contract value for the contract period shall be considered.

(iv) Foreign Exchange variation:

In case of the contract for procurement is in foreign currency then the applicability of the foreign exchange variation should be clearly defined. The period of the applicability of the exchange variation should be restricted according to the delivery schedule. Ordinarily the exchange variation should not be permitted in the extended period of the delivery.

5) EARNEST MONEY AND SECURITY DEPOSIT:-

Every tenderer, while submitting his tender, shall deposit the earnest money specified in the NIT (Rs. 1,71,600/-)

The earnest money furnished by the successful tenderers on whom the purchase order is placed shall be converted into security deposit as a guarantee for faithful and satisfactory execution of the purchase order up to warranty period. **The security deposit in case of Purchase Order shall be 2% of the contract value.**

The EMD of the unqualified bidders will be returned by the purchaser without any interest, as promptly as possible, within 30 days after declaration of qualification result and that of unsuccessful bidders within 15 days of the execution of the contract with the selected bidder.

Provided further that the provision of this regulation may not apply to a Public Sector undertaking of the Central/ State Government, firms borne on D.G.S & D / DS&D Haryana rate contract, firm registered with Director of Industries, Haryana or with National small industries corporation, Govt. of India or the firms having permanent EMD of Rs. 10.00 Lac at the respective project / office.

The earnest money /security deposit shall be forfeited in part or in full under the following circumstances:-

- I. If the tenderer withdraws his tender at any stage during the currency of his validity period.
- II. If the P.O. has been issued but the supplier refuses to comply with it.
- III. Where the purchase order has been complied with but the supplier stops making the supplies after partially fulfilling the purchase order.
- IV. In the event of breach of a contract in any manner.
- V. In the case of evidence of cartel formation by the bidder(s).

In case where the Performance Bank Guarantee has been agreed by the supplier, the security deposit shall be released on the completion of the supplies. In other cases the same shall be released only after warrantee period on the certificate of the purchaser for satisfactory completion of the warrantee period.

No interest shall be paid on EMD for the period it remains deposited with HPGCL.

6) PAYMENT TERMS:-

Subject to any deductions which the purchaser may be authorized to make under this contract, the payment for the material shall be made as under:-

100% payment shall be made after 21 days of receipt of material at site in good condition and after receipt/ adjusting of 10% Performance Bank Guarantee (if applicable) and on submission of requisite documents as per Purchase Order .

OR

90% payment against documents through bank after 21 days of receipt of intimation from the bank and after receipt/ adjusting of 10% Performance Bank Guarantee (if applicable) and on submission of requisite documents as per Purchase Order and balance 10% after receipt of material in good condition.

Note:-

- Receipt of material at site shall mean receipt of material in accordance with terms of the Contract after test and inspection by the Purchaser or his authorized agent, along with the requisite documents specified in clause no. 10.
- In case any payment term has been agreed in deviation to the above, loading in the prices shall be made @0.50% per week or part thereof at the time of preparation of comparative statement.
- In case any damage, shortage, etc, are noticed on receipt of material by the consignee, claims shall be lodged with the suppliers and the amounts due to him withheld or the bank guarantee shall not be released till the claims are satisfactorily settled by the supplier.
- In case of defects/damages in the material being noticed at any time, including during the warranty period, claims shall be lodged with the firms to make good the defects/damages or replace the material within a reasonable period not exceeding 30 days from the date of notification of the defects to the suppliers. In case of the supplier/firm failing to do so, the damages/defects may be got rectified by the corporation and the claim may be adjusted from the supplier's/firm's pending dues and/ or security deposit against this or any other contract in force and the balance be got made good by the supplier. Alternatively, the corporation may dispose-off the damaged/defective material and set off the sale proceeds against its claim against the supplier.

7) MODE OF PAYMENT:-

Payment shall be released by the Sr. Accounts Officer, RGTPP by account payee cheque payable at _____/RTGS/NEFT. For payment through RTGS/NEFT, the supplier will provide complete bank details viz. Name of Bank/Branch, Account Number, Type of Account, IFSC Code etc. to Sr. Accounts Officer, RGTPP.

8) DELIVERY PERIOD AND DAMAGES FOR DELAY:-

The date of delivery of material as specified in the purchase order shall be the essence of the contract between the supplier and the Corporation, and the delivery of each consignment must be made as per given delivery schedule in Annexure-I of NIT.

No supplies/ consignments received after the date on which they were actually due according to the terms of the purchase order, shall be accepted by the consignee, except with the written approval of the purchasing authority.

Even in case of acceptance of delayed supply the supplier shall be liable to pay @ 0.5% per week or part there-off of the delay of the value of the goods so delayed where the part supply is acceptable and of the PO value where part supply is not acceptable, subject to a maximum of 5% of the contract value.

The delivery period shall be reckoned from the 7th day of issue of P.O./ L.O.I. whichever is earlier.

Property in the material shall not pass to the purchaser unless and until the material has been delivered to the consignee in accordance with the terms and conditions of P.O. Firm will be informed 5 days in advance for execution of work at site.

9) TESTS AND INSPECTIONS:-

The tests and inspections shall normally be arranged at the supplier's premises before the material is dispatched to the Corporation, and copy of the inspection/ test report in such case shall be attached by the supplier in original along with Railway Receipt/ GR and other requisite document as per P.O. **For this purpose, the supplier shall give at least 15 days notice to the purchasing authority to arrange for the inspection of goods offered for dispatch, on different occasions, before dispatch if inspection is not waived off. In addition to this, the supplier has to submit copy of test certificates along with inspection call. Without test certificates, pre-dispatch inspection call will not be accepted and delay on this account will be on the part of the supplier.**

HPGCL has the right to get the pre-dispatch inspection done from third party along with HPGCL representative.

In case, the supplier is not having its own testing facility and any agency has not been specifically mentioned in the PO, then the supplier will submit the test certificates issued from any Govt. approved laboratory.

Supplier shall ensure that all the facilities necessary for carrying out the inspection/prescribed tests are made available to the inspection officer at the point of inspection to be carried out.

In case of non conduct of testing due to non availability of material, the charges of the inspecting officers shall be borne by the supplier.

The inspection call received after expiry of delivery period may or may not be entertained.

Supplier shall dispatch the material with copy of inspection report and manufacturer test certificate, immediately after inspection but not later than 10 (Ten) days failing which the delay shall be on the part of supplier for the purpose of L.D. In case of waiver of inspection, supplier shall dispatch the material within 10 days of receipt of waiver letter or 15 days of dispatch of waiver letter whichever is earlier. In case prices are F.O.R destination basis, even then the time period as above will be allowed for dispatch of material.

10) DOCUMENTATION:-

The supplier shall submit a set of documents as detailed below well in time to the following offices for processing his bill for pass and payment. {as applicable}

A) Concerned Executive Engineer (Purchaser copy)-

- | | | |
|-----------------------------------|---|---------------|
| a) Acceptance of PO | b) Readiness of material/ inspection call | |
| c) Copy of invoice | d) Copy of RR/GR | |
| e) Advance intimation of dispatch | f) Test Certificates | g) E-Way Bill |

B) Concerned Sr. A.O. (Accounts copy)

- | | |
|---------------------------------------|--|
| a) Copy of invoice in triplicate | b) GST Certificate(as per annexure attached) |
| c) Proof of Insurance charges | d) Guaranty/ Warranty Certificate |
| e) Inter-changeability Certificate | f) Copy of inspection report |
| g) D.D on account of security deposit | h) Performance Bank Guaranty. |
| k) Copy of R.R./G.R. | f) E-way Bill |

C) Concerned Executive Engineer/ Stores (Consignee copy)

- | | | |
|---|------------------------------|---------------|
| a) Copy of Invoice. | b) Copy of Inspection Report | |
| c) Dispatch particulars | d) Copy of RR/GR. | e) E-Way Bill |
| f) GST undertakings and TDS undertaking | | |

D) Appropriate branch of State Bank of India, if document are to be negotiated through Bank

- | | |
|--------------------|---------------------|
| a) Copy of invoice | b) Original RR/ GR. |
|--------------------|---------------------|

Note:-

If the documents shown above are not sent to the appropriate office within due period then bank document will not be retired and the responsibility for demurrage/ wharfage or auction of material will be on the supplier's account.

No interest, what so ever on any account shall be paid by HPGCL.

Bank Charges if any shall be borne by the supplier.

11) PACKING:-

The supplier shall provide for secure protection & packing of the equipment in accordance with the best established Practices so as to protect the equipment from damages. Any breakage, damage and/or pilferage including when in transit arising from faulty packing shall be the responsibility of the supplier. All packages shall be visibly marked mentioning purchase order number & name of buyer in bold letters & must contain copies of challans/packing slips inside.

12) MODE OF TRANSPORT:-

The normal mode of transport for dispatch of material from supplier's end shall be by train / approved road transporter of HPGCL.

13) TRANSIT INSURANCE:

(A) The material shall be insured against all risks and loss for its full delivered value up to the destination station. The insurance charges from dispatching station up to the destination station will be borne as per provision in the PO. The Supplier shall produce insurance cover and also a stamped acknowledgement receipt of the insurance company for the premium paid by them in support of their claim, if any. The consignee shall report losses/damage to the Supplier at the earliest possible of the receipt of the consignment at the site.

It will, however, be the responsibility of the Supplier to prefer timely claim on the insurance underwriters. The Supplier will make good the losses / shortages, replace / repair the damage to the consignee irrespective of the claim lodged / to be lodged with the insurance underwriters or other appropriate authorities.

The Supplier shall supply or replace such material or parts as are lost in transit within reasonable time based on the delivery period free of charges.

The Supplier shall be responsible for all loss, destruction, damage, deterioration of the material from any causes whatsoever in the course of transit from the Supplier to the consignee. If insurance is in the scope of consignee, the firm will intimate to consignee advance about dispatch of material otherwise all the losses, if any will be in the account of supplier.

(B) In case of supply of material against documents through bank, no material shall be accepted without proper transit insurance.

14) PERFORMANCE BANK GUARANTEE:-

Supplier shall submit bank guarantee of the Nationalized Bank equivalent to 10% of the order value in the prescribed Performa valid up to 21 months from the date of dispatch of material or 3 months after completion of G/W period unless otherwise agreed.

15) GUARANTEE/WARRANTY:-

The supplier shall be made responsible to replace free of cost, with no transportation or insurance cost to the Corporation, up to the destination the whole or any part of the material, which in normal and proper use proves defective in quality or workmanship, subject to the condition that the defect is noticed within 12 months from the date the material is used or 18 months from the date of dispatch, whichever period may expire earlier. The consignee or any other officer of the corporation actually using the material will give prompt notice of each such defect to the supplier as well as the Purchasing Authority and the Sr. A.O. The replacement shall be effected by the supplier within reasonable time, but not, in any case, exceeding 45 days.

The supplier shall, also, arrange to remove the defective supply within a reasonable period, but not exceeding 45 days from the date of issue of the notice in respect thereof, failing which, the corporation shall reserve the right to dispose-off the defective material in any manner considered fit by it at the sole risk and cost of the supplier. Any sale proceeds of the defective material after meeting the expenses incurred on its custody, disposal, handling etc. shall, however, be credited to the supplier's account and set off against any outstanding dues of the corporation against the supplier.

The supplier shall furnish warrantee certificate stating that, "we will be responsible to replace within 45 days of the date of issue of notice, free of cost, with no transportation or insurance-cost to the Corporation, up to the destination the whole or any part of the material supplied by us against P.O. No.- _____ dated _____, within a period of _____ which in normal and proper use proves defective in quality or workmanship, within 12 months from the date the material received by the consignee or 18 months from the date of dispatch whichever period may expire earlier".

The provisions shall, mutatis mutandis apply to the replaced material. In case the material is again found to be defective within a period of 12 months of its replacement, it shall also have to be replaced similarly by the supplier (Guarantee/warrantee clause shall be applicable to the replaced material also).

16) FORCE MAJEURE:-

The delay in delivery of the supply may be treated as force majeure to the supplier only if:-

- i) The delay in manufacture or delivery of the material /equipment on order result from any causes arising out of compliance with regulations, orders or instructions of the Central or State Governments, acts of God, acts of Civil & Military authority, fires, floods, strikes, lock-outs, freight embargoes, war-risk riots and civil commotion and
- ii) The supplier's request for extension of the delivery period along with all necessary evidence, before the expiry of the schedule date (s) of delivery.
Non -availability of raw material or any other similar cause shall not be considered as a force majeure circumstance.

17) DEMURRAGES:-

The Supplier shall be responsible for all demurrage charges due to late receipt of G.R. and non-receipt of prior intimation of dispatch of material to the consignee. G.R. through bank other than specified one will not be accepted. If any consignment and or its relevant shipping document are dispatched to an incorrect address / destination or parts of the case, the additional expenses involved & delay in delivery shall be to the Supplier's account.

18) ARBITRATION: -

All matters, questions, disputes, differences and / or claims arising out of and / or concerning, and /or in connection with, and /or in consequence of, and /or relating to the contract whether or not obligations of either of both the Supplier and the Corporation under

that contract be subsisting at the time of such dispute and whether or not the contract has been terminated or purported to be terminated or completed, shall be referred to the sole arbitration of MD, HPGCL or an officer appointed by the MD, HPGCL as his nominee. The award of the Arbitrator shall be final and binding on both the parties to the contract.

The objection that the Arbitrator has to deal with the matters, to which the contract relates, in the course of his duties or he has expressed his views on any or all of the matters in dispute or difference, shall not be considered as valid objection.

The arbitrator may, from time to time, with the consent of the parties to the contract enlarge the time for making the award. The venue of the arbitration shall be the place from which the acceptance of offer is issued or such other place as the Arbitrator, in his discretion, may determine.

All arbitration proceedings under this regulation shall be governed by the provisions of the Arbitration and Conciliation Act, 1996 and the Rule there under, with any statutory modification thereof for the time being in force.

19) LAWS GOVERNING CONTRACTS:-

All contracts shall be governed by the laws of India for the time being in force.

Irrespective of the place of delivery, place of performance or place of payment under a contract, the contract shall be deemed to have been made at the place from which the acceptance of tender has been issued.

Jurisdiction of Courts- The courts of the place from where the acceptance of tender has been issued shall alone have exclusive jurisdiction to decide any dispute arising out of or in respect of the contract.

20) RISK PURCHASE:-

In the case of delay or non-supply of any or all the material on the dates they are due, the HPGCL will have a right to refuse to accept such delayed supplies and to make the purchase of the material so delayed or not supplied from any alternative source or through departmental manufacture, at the sole risk and cost of the supplier. Any extra expenditure incurred on such purchase or departmental manufacture shall be recoverable in full from the supplier in addition to the Corporation's right or claim for applicable liquidated damages or penalty.

21) INTERCHANGEABILITY:-

Supplier shall furnish inter-changeability certificate, wherever applicable, that all the spares are identical in construction, interchangeable and suitable to the equipment installed at site.

22) SET OFF:-

Any sum of money due and payable to the supplier under the contract (including security-deposit returnable to the supplier) may be appropriated by the HPGCL and set-off against any claim of the Corporation for the payment of a sum of money arising out of under that or any other contract entered into by the supplier with the HPGCL.

23) PATENT RIGHT:-

The supplier shall indemnify the Purchaser against all third-party claims of infringement of patent, trademark or industrial design rights arising from use of the Goods or any part thereof in India.

24) SUBLETTING AND ASSIGNMENT:-

The Supplier shall not, sublet, transfer or assign the contract or any part thereof or interest therein or advantage thereof in any part thereof in any manner whatsoever without prior consent of the purchaser.

25) PLACEMENT OF ORDER:- It is not binding on this office to place the P.O for all the items mentioned in the NIT. The quantity of various items mentioned in the tender enquiry notice can be increased or decreased by this office as per requirement.

Note:-

1. Unless agreed otherwise the above terms and conditions of the contract will form the part of the purchase order after finalizing the procurement proposal. The word tenderer where ever used above shall be read as supplier. The non applicability / modification in the aforesaid clauses if agreed shall be mentioned / attached in / with the purchase order specifically.

2. Any other term not defined in instructions to the bidder or above terms and conditions should be interpreted as defined in "HPGCL Works & Purchase Regulation 2015".

3. The term "Bid" and "tender" and their derivatives ("Bidder / Tenderer" "Bidding / Tendering") are synonymous. Singular also means plural.

XEN/MM-I
For Chief Engineer/RGTPP,
HPGCL, Khedar, Hisar.

SPECIFICATIONS / SCHEDULE OF DEIVERY OF MATERIAL

Item Description & Specifications			Name of Consignee	Destination of Consignment	Delivery Period
Sr. No.	Description	Qty. (Nos.)			
1.	Carrying idler suitable for 1200mm width belt, Shell length – 465mm, Shaft length – 497mm, Shell dia – 152.4mm, Troughing Angle – 35 degree As per drawing attached (Annexure-I) and test required (Annexure-X)	2150	XEN/Store, RGTPP, HPGCL, Khedar, Hisar.	Permanent Store, RGTPP, HPGCL, Khedar, Hisar.	The delivery of material shall be taken on staggered basis as per actual site requirement from time to time within the contract period. The requirement of quantity will be intimated to supplier by consignee i.e. XEN/Store, RGTPP from time to time. Firm will confirm the readiness of material and offer pre-dispatch inspection (PDI) within 80 days after raising of indent by the consignee. Firm shall dispatch the material within 10 days after PDI/PDI waiver. The contract period will be one year from date of issue of LOI/PO whichever is earlier, which may further be extended for a period of 03 months with same prices and terms & conditions at the sole discretion of HPGCL.
2.	Return idler suitable for 1200mm width belt, Shell length – 700mm, Shaft length – 742mm, Shell dia – 152.4mm, Troughing Angle – 10 degree As per drawing attached (Annexure-II) and test required (Annexure-X)	250			
3.	Impact idler suitable for 1200mm width belt, Shell length – 465mm, Shaft length – 497mm, Shell dia – 127mm, Idler dia with rubber disc – 170mm Troughing Angle – 35 degree As per drawing attached (Annexure-III) and test required (Annexure-X)	200			
4.	Non Magnetic carrying idler suitable for 1200mm width belt, Shell length – 465mm, Shaft length – 497mm, Shell dia – 152.4mm, Troughing Angle – 35 degree As per drawing attached (Annexure-IV) and test required (Annexure-X)	12			
5.	Self aligned Frame (Bracket) for 1200mm belt width 35 degree Troughing Training idlers with base frame and brackets along with guide rollers. As per drawing attached (Annexure-V)	50			
6.	Flat idler suitable for 1200mm width belt, Shell length – 1400mm, Shaft length – 497mm, Shell dia – 152.4mm, Bearing dia– 35mm Notch Size – 22x12 As per drawing attached (Annexure-VI) and test required (Annexure-X)	10			
7.	Bracket for Mounting of 2 roll Return idlers 1200mm width belt As per drawing attached (Annexure-VII)	100			
8.	Flat Carrying idler and Flat return idler for dribble belt Shell length – 2200mm, Shaft length – 2236mm, Shell dia – 114.3mm, As per drawing attached (Annexure-VIII) and test required (Annexure-X)	40			
9.	Impact idler suitable for 1600mm width belt, Shell length – 600mm, Shaft length – 632mm, Shell dia – 127mm, Idler dia with rubber disc – 170mm Troughing Angle – 35 degree As per drawing attached (Annexure-VII) and test required (Annexure-X)	100			
10.	Carrying idler suitable for 1600mm width belt, Shell length – 600mm, Shaft length – 632mm, Shell dia – 152.4mm, Troughing Angle – 35 degree As per drawing attached (Annexure-I) and test required (Annexure-X)	200			
11.	Non Magnetic carrying idler suitable for 1600mm width belt, Shell length – 600mm, Shaft length – 632mm, Shell dia – 152.4mm, Troughing Angle – 35 degree As per drawing attached (Annexure-II) and test required (Annexure-X)	06			
12.	Return idler suitable for 1600mm width belt, Shell length – 900mm, Shaft length – 942mm, Shell dia – 152.4mm, Return Angle – 10 degree As per drawing attached (Annexure-VIII) and test required (Annexure-X)	100			

13.	Frame (Self align Bracket) suitable for 1600mm width belt, Troughing Angle – 35 degree, taining base frame and brackets along with guide rollers As per drawing attached (Annexure-V)	20			
14.	Flat idler suitable for 1600mm width belt, Shell length – 1000mm, Shaft length – 1842mm, Shell dia – 152.4mm, Bearing dia– 35mm Notch Size – 28x12 As per drawing attached (Annexure-IX) and test required (Annexure-X)	06			
15.	Guide roller as per drawing attached (Annexure-V)	100			

Note: Firm may depute their engineer to visit at RGTPP, Hisar, Haryana for taking actual dimensions at site to avoid any fitment issue at later stage. Drawings are attached in the NIT .

Note:

Detailed drawings at Annexure-1A

1. Tenderer are requested to confirm in their tender that material will be supplied strictly as per specifications given in the NIT.
2. Participating firm has to comment upon and accept all our standard terms and conditions of NIT. In case of non-comment of any terms and conditions, it will be assumed that these term and conditions are acceptable to the tenderer. Firm has to quote the rates after considering all the factors/ clause of NIT.
3. In case of deviation from the standard terms and conditions of NIT, offer of the firm shall be liable to rejected.
4. The bidder must upload all Annexure dully signed & stamped along with NIT documents.
5. **Firms are requested to fill the GST % and GST amount in price bid carefully.**
6. **Tender fees is exempted only for Haryana based MSME (manufacturing) firms.**
7. **EMD is exempted only for Haryana based MSME (manufacturing) firms, firms borne on D.G.S. & D/DS&D Haryana rate contracts, firms registered with the director of Industries Haryana, Public sector undertakings of the central/Haryana State Government and NSIC firms (Govt. of India).**
8. **Firms failing to deposit Tender Fee or EMD shall be out rightly rejected.**

Signature & Stamp of Bidder

Annexure - I

VIEW - AA

$+0.0$
 -0.5
W

ITEMS LIST:

10	RAIN CAP	2	NYLON-6	
9	DUST COVER	2	CRCA GR. DDD	IS:513
8	EXTERNAL CIRCLIPS	4	SPRING STEEL	IS:3075
7	OUTER LABYRINTH	2	NYLON-6	
6	INNER LABYRINTH	2	NYLON-6	
5	INNER SEAL	2	NYLON-6	
4	BEARING	2	SEIZE RESISTANT	SKF/FAG
3	BEARING HOUSING	2	CRCA GR. DDD	IS:513
2	SPINDLE	1	C40/EN-8	IS:1570/BS:970
1	ROLLER	1	ENW. YST-210	IS:8598
IT.NO.	DESCRIPTION	QTY.	MATERIAL	SPECIFICATION

CLIENT: HARYANA POWER GENERATION CORPORATION LTD.
PROJECT: RAJIV GANDHI THERMAL POWER PLANT, HISAR

EXECUTIVE ENGINEER/CHP
RGTPP, HPGCL
Kheddar (Hisar)

ASSISTANT ENGINEER/CHP
RGTPP, HPGCL
Kheddar (Hisar)

NOTES

- ALL DIMENSIONS ARE IN mm.
- IDLERS DROP IN TYPE, LIFE LUBRICATED AS PER IS:8598/1987 TYPE "A".
-
- PAINING : ONE COAT EACH OF ZINC PHOSPHATE PRIMER AND SYNTHETIC ENAMEL PAINT OF DA GREY COLOUR.

GA OF CARRYING IDLER FOR 1200MM BW 1600 mm B/D

D I M E N S I O N S T A B L E

PO SL	STORE CODE	BW	ØD	L	L1	L2	L3	Ød1	w	t	BRG. NO.	
01	13165107	1200	152.4	465	473	497	12	30	32	22	5.4	6306
02	13165106	1600	152.4	600	608	632	12	35	35	28	5.4	6307

Annexure - II

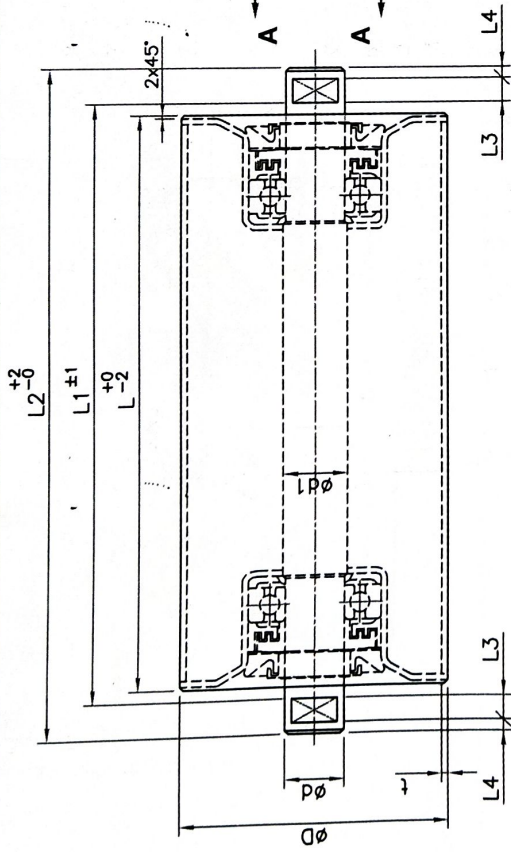
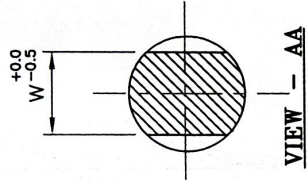
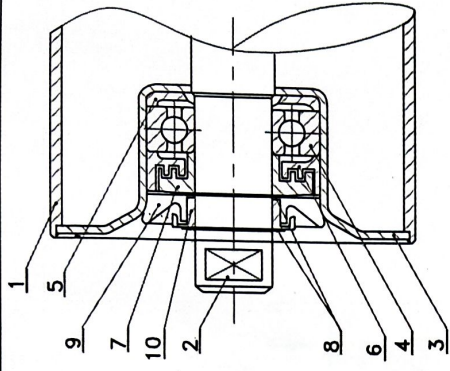

10	RAIN CAP	2	NYLON-6	
9	DUST COVER	2	CRCA GR. DDQ	IS:513
8	EXTERNAL CIRCLIPS	4	SPRING STEEL	IS:3075
7	OUTER LABYRINTH	2	NYLON-6	
6	INNER LABYRINTH	2	NYLON-6	
5	INNER SEAL	2	NYLON-6	
4	BEARING	2	DEEP GROOVE BALL BEARING	SKF/FAG
3	BEARING HOUSING	2	CRCA GR. DDQ	IS:513
2	SPINDLE	1	C40/EN-8	IS:1570/BS:970
1	TUBE	1	ERM PIPE	IS:9295/83
IT.NO.	DESCRIPTION	QTY.	MATERIAL	SPECIFICATION

HARYANA POWER GENERATION CORPORATION LTD.

RAJIV GANDHI THERMAL POWER PLANT, HISAR

Assistant Engineer/CHP
RGTPP, HPGCL
Khedar (Hisar)

Executive Engineer/CHP
RGTPP, HPGCL
Khedar (Hisar)

D I M E N S I O N S T A B L E

PO SL	STORE CODE	BW	ØD	L	L1	L2	L3	L4	Ød1	w	t	BRG. NO.	QTY NOS.
01	13165107 1010006	1200	152.4	700	708	742	12	5	30	32	22	5.4	6206 200
02	13165106 1000007	1600	152.4	900	908	942	12	5	35	38	28	5.4	6207 200

NOTES

- ALL DIMENSIONS ARE IN mm.
- IDLERS DROP IN TYPE, LIFE LUBRICATED AS PER IS:8598/1987 TYPE 'B'.
- ~~PAINTING : ONE COAT EACH OF GREY OXIDE PRIMER AND SYNTHETIC ENAMEL PAINT OF DA GREY COLOUR.~~

Annexure - IV

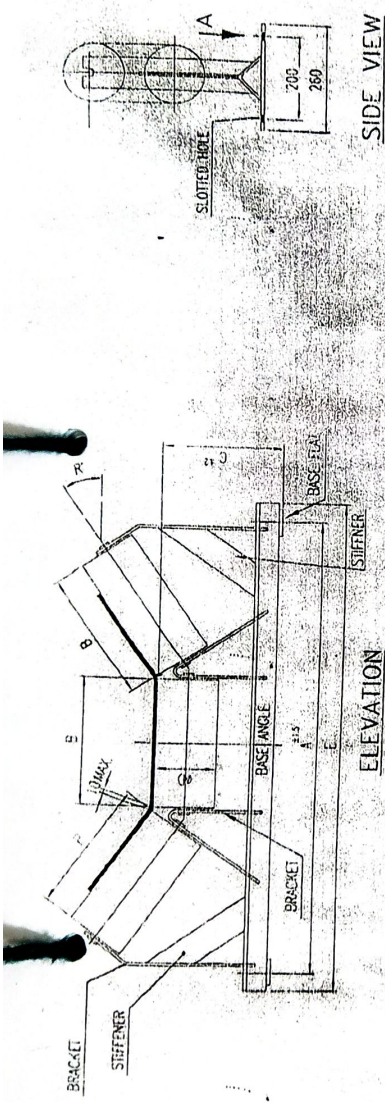

SIDE VIEW

ELEVATION

B.W.	SYM.	R (DEGS)	A	B	C	GD	E	m	n	b1	U	BOLT	SHAFT DIA. AT BRG. GA	BRG. NO.	BASE ANGLE	BRACKET	STIFFENERS	BASE FLAT
1200	CH20210	50	1490	465	290	192.4	1590	4	12	22	18	M16	30	6006	E 60-90x6	FLAT 75x8	FLAT 50x6	FLAT 65x8
1600	CH16035	35	1890	600	290	152.7	1980	4	12	28	18	M16	35	6007	E 60-100x8	FLAT 75x8	FLAT 50x6	FLAT 75x8

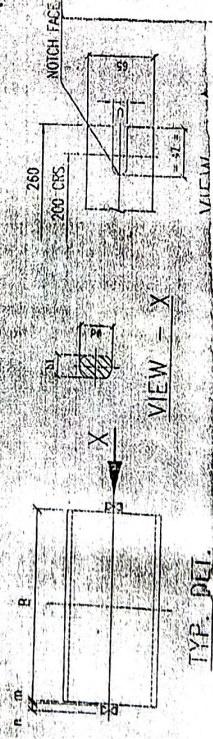

TYPE DETL

- Note:
- 1) ALL DIMENSIONS ARE IN MM
 - 2) ALL WELDS ARE 6MM FILLET WELD
 - 3) MOUNTING DIMENSIONS ARE AS PER IS: 6598.
 - 4) ALL ROLLERS ARE DROP IN TYPE & LIFE SEALED LUBRICATED AND MINIMUM WORKING LIFE OF BEARING: 10,000 WORKING HOURS.
 - 5) ALL BEARINGS FOR ROLLERS ARE DEEP GROOVE BALL BEARING AND SKIFFAG MAKE ONLY WITH DOUBLE LABYRINTH SEAL ON EXTERNAL SIDE & CONTACT NYLON SEAL ON INNER SIDE.

Material specification:

- SHELL BEARING HOUSING: - Stainless Steel, Grade SS-304
 - SPINDLE: - Steel EN-8 as per BS-9704/OC8 as per IS:1570
 - BEARING: - Deep Groove Ball bearing of SKF FAG make.
 - INNER SEAL, LABYRINTHS, RAINGAP: - Nylon-6
 - DUST COVER: - CRCA as per IS: 513.
 - LUBRICATION: - Autoplex hi-lithium based grease of reputed make
 - GIRCLIP: - spring steel to IS: 3075
 - PAINTING: - Lacquering/Red Oxide primer and Synthetic Enamel Paint of grey colour.
 - IDENTIFICATION: - Logo of company along with year or month of manufacturing will be punched/engraved on the face of bearing housing.
 - SUBMISSION OF DRAWING: - firm will submit detail drawing for approval from HPGCL before manufacturing of material.
- W/ Collo shell 5.4mm thickness, SS-304

Executive Engineer/CHP
 RGTPP, HPGCL
 Khedar (Hisar)

Assistant Engineer/CHP
 RGTPP, HPGCL
 Khedar (Hisar)

Annexure - VI

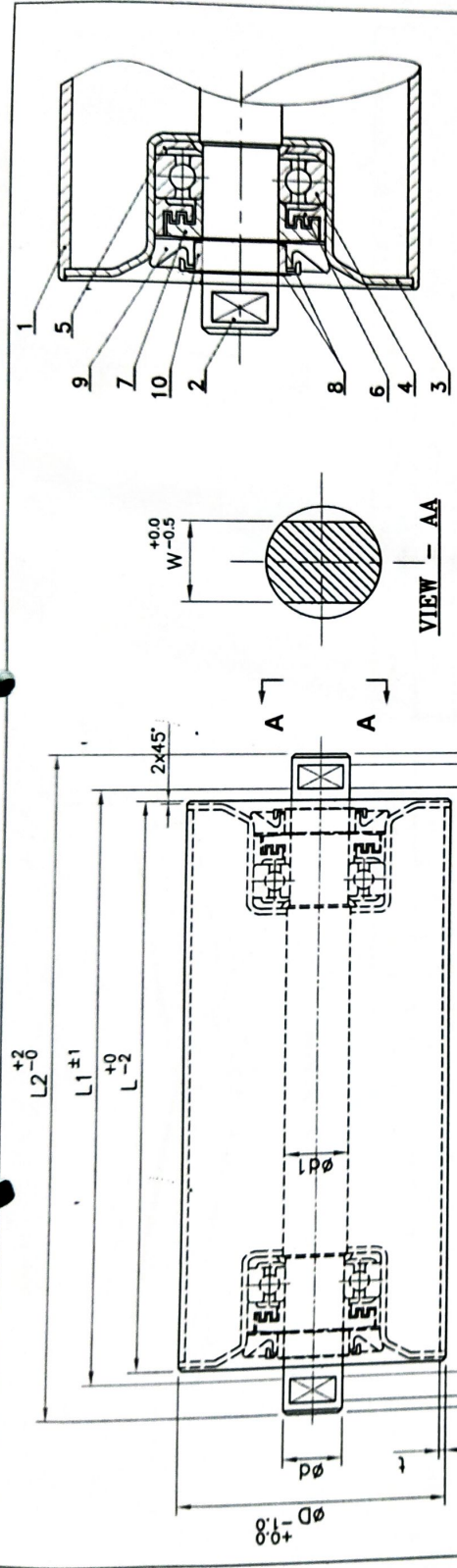

IT.NO.	DESCRIPTION	QTY.	MATERIAL	SPECIFICATION
10	RAIN CAP	2	NYLON-6	
9	DUST COVER	2	CRCA GR. DDD	IS:513
8	EXTERNAL CIRCLIPS	4	SPRING STEEL	IS:3075
7	OUTER LABYRINTH	2	NYLON-6	
6	INNER LABYRINTH	2	NYLON-6	
5	INNER SEAL	2	NYLON-6	
4	BEARING	2	DEEP GROOVE	SKF/FAG
3	BEARING HOUSING	2	CRCA GR. DDD	IS:513
2	SPINDLE	1	EN-8/40C8	BS:970/IS:1570
1	TUBE	1	ERM. YST-210	IS:9295/83

D I M E N S I O N S T A B L E

PO SL	STORE CODE	BW	ØD	L	L1	L2	L3	L4	Ød1	w	t	BRG. NO.	QTY. NOT NOS.
01		1200	152.4	1400	1408	1442	12	5	35	38	28	5.4	6207

NOTES

1. ALL DIMENSIONS ARE IN mm. U.O.M
2. ALL SHARP CORNERS TO BE GROUNDED SMOOTH.
3. IDLERS DROP IN TYPE, LIFE LUBRICATED AS PER IS:8598/1987 TYPE "B".
4. SHELL TO BE M.S. ERM TUBE, WALL THICKNESS 5.4MM WITH TOLERANCES AS PER IS:9295.
5. SPINDLE TO BE EN8/40C8 AS PER BS:970/IS:1570.
6. SINGLE ROW DEEP GROOVE BALL BEARING OF SKF/FAG MAKE WITH MINIMUM LIFE OF 30000 WORKING HOURS.
7. ALL IDLERS TO BE PROVIDED WITH DOUBLE LABYRINTH SEALS.
8. IDLERS SHALL TO BE DUST PROOF & WATER PROOF.
9. TR OF ROLLER TO BE LESS THAN 1.6 AS PER IS:8598.
10. FRICTION COEFFICIENT OF IDLER SHALL NOT BE MORE THAN 0.02.
12. PAINTING : ONE COAT EACH OF ZINC CHROMATE PRIMER & FINISH SYNTHETIC ENAMEL PAINT OF DA GREY SHADE.



Assistant Engineer/CHP
RGTPP, HPGCL
Kheddar (Hisar)

Executive Engineer/CHP
RGTPP, HPGCL
Kheddar (Hisar)

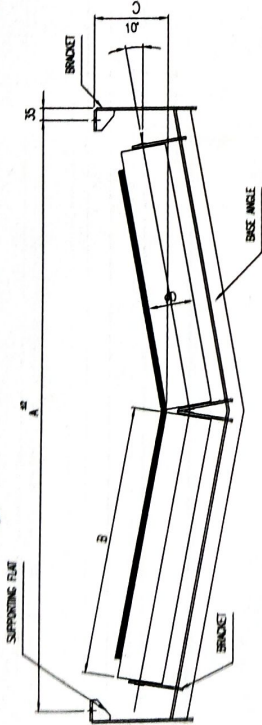
Annexure III

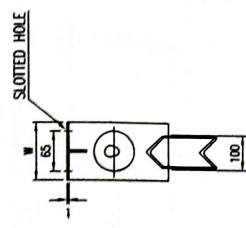

ELEVATION



SIDE VIEW

B.W.	SYML	R (DEG.)	A	B	C	ØD	m	n	p	b1	U	BOLT	SHAFT DIA AT BRG. Ød	BRG. NO.	BASE ANGLE	BRACKET T (WxH)	ROLLER BRACKET	STIFFENER S
1200	R1120/10	10	1480	700	200	152.4	4	12	5	22	18	M16	30	6206	L 90X90X6	FLAT 125X6	FLAT 65X8	FLAT 50X6
1500	R1150/10	10	1900	900	235	152.4	4	12	5	28	18	M16	35	6207	L*100X100X8	FLAT 125X6	FLAT 75X8	FLAT 50X6

Assistant Engineer/CHP
RGTPP, HPGCL
Kheddar (Hisar)

Executive Engineer/CHP
RGTPP, HPGCL
Kheddar (Hisar)

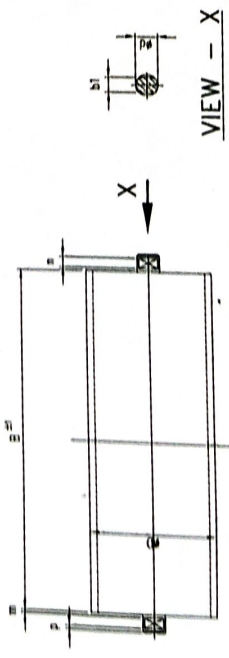

TYP. DET. OF ROLLER

- NOTES:
1. ALL DIMENSIONS ARE IN MM.
 2. ALL WELDS ARE 6MM FILLET WELD.
 3. ALL OLDER TUBES ARE ERW PIPES AS PER IS. SIZE.
 4. FOR IMPACT ROLLER TUBE 1029 X 6.3 THK.
 5. WORKING SHALL BE MADE OF PRESSED STEEL OF OVER SHEETS OF 3.15MM.
 6. ALL ROLLER SHAFTS ARE OF Ø48 AS PER ESSON.
 7. WORKING DIMENSIONS ARE AS PER ESSON.
 8. ALL ROLLER ARE ERW IN TYPE A & IT SEALS LUBRICATED AND MINIMUM WORKING LIFE OF BEARINGS TO 1000 WORKING HOURS.
 9. ALL BRGS FOR ROLLERS ARE DEEP GROOVE BALL BRG AND SKF/RAC MAKE ONLY WITH DOUBLE LUBRICATION SEAL ON EXTERNAL SIDE & CONTACT IN OIL SEAL ON INNER SIDE.
 10. PAINTING - THE COAT OF RED OXIDE PRIMER ROLLER FRAME-SOME COAT OF EPOXY PRIMER AFTER SHOT BLASTING THEN COAT OF EPOXY PAINT OF SMOKE GREY COLOR.
 11. FOR OLDER SCHEDULE REFER DDC NO. REL-HRTPP-KH-143-S-1987

HARYANA POWER GENERATION CORPORATION
PANICHERITLA, HARYANA

G. A. OF V-TYPE(10° ANGLE) RETURN IDLER

2x6000MW HISAR THERMAL POWER PLANT, HISAR,

[REDACTED]

[REDACTED]

[REDACTED]

[REDACTED]

[REDACTED]

[REDACTED]

[REDACTED]

[REDACTED]

[REDACTED]

[REDACTED]

[REDACTED]

[REDACTED]

[REDACTED]

[REDACTED]

[REDACTED]

[REDACTED]

[REDACTED]

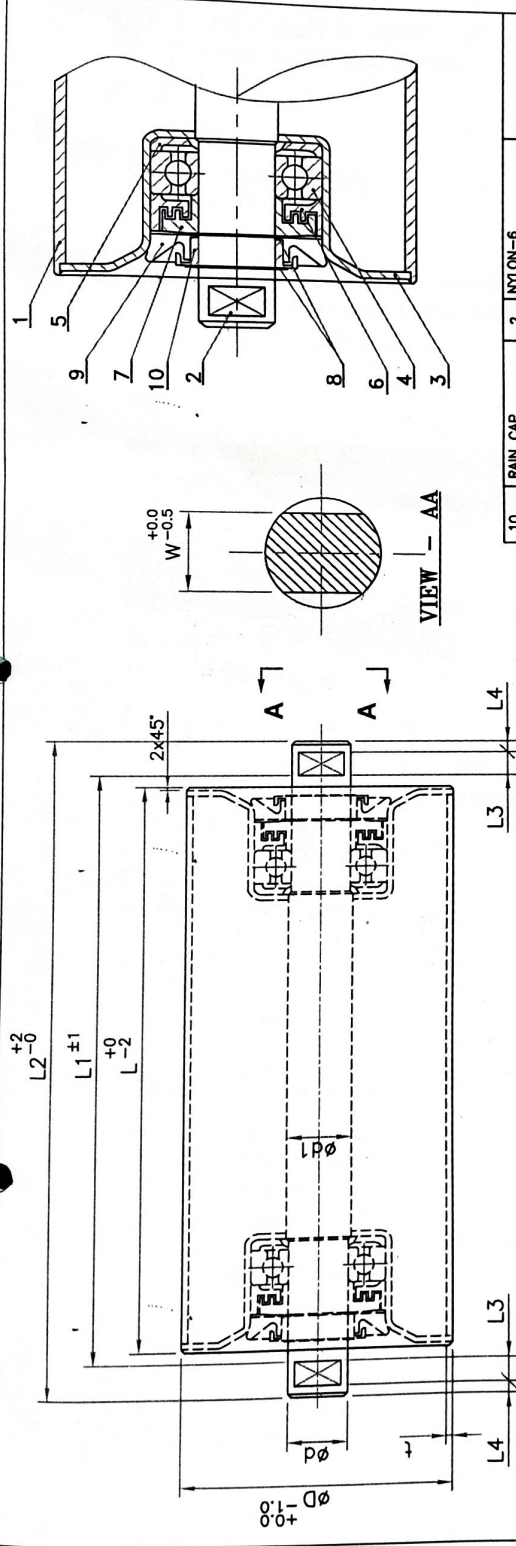

D I M E N S I O N S T A B L E

PO SL	STORE CODE	BW	ØD	L	L1	L2	L3	L4	Ød1	w	t	BRG. NO.	QTY NOS.
02		1600	152.4	1800	1808	1842	12	5	35	38	28	5.4	6207

IT.NO.	DESCRIPTION	QTY.	MATERIAL	SPECIFICATION
10	RAIN CAP	2	NYLON-6	
9	DUST COVER	2	CRCA GR. DDO	IS:513
8	EXTERNAL CIRCLIPS	4	SPRING STEEL	IS:3075
7	OUTER LABYRINTH	2	NYLON-6	
6	INNER LABYRINTH	2	NYLON-6	
5	INNER SEAL	2	NYLON-6	
4	BEARING	2	DEEP GROOVE	SKF/FAG
3	BEARING HOUSING	2	CRCA GR. DDO	IS:513
2	SPINDLE	1	EN-8/40C8	BS:970/IS:1570
1	TUBE	1	ERW, YST-210	IS:9295/83

NOTES

1. ALL DIMENSIONS ARE IN mm. U.O.M.
2. ALL SHARP CORNERS TO BE GROUNDED SMOOTH.
3. IDLERS DROP IN TYPE LIFE LUBRICATED AS PER IS:8598/1987 TYPE "B".
4. SHELL TO BE M.S. ERW TUBE, WALL THICKNESS 5.4MM WITH TOLERANCES AS PER IS:9295.
5. SPINDLE TO BE EN8/40C8 AS PER BS:970/IS:1570.
6. SINGLE ROW DEEP GROOVE BALL BEARING OF SKF/FAG MAKE WITH MINIMUM LIFE OF 30000 WORKING HOURS.
7. ALL IDLERS TO BE PROVIDED WITH DOUBLE LABYRINTH SEALS.
8. IDLERS SHALL TO BE DUST PROOF & WATER PROOF.
9. TIR OF ROLLER TO BE LESS THAN 1.6 AS PER IS:8598.
10. FRICTION COEFFICIENT OF IDLER SHALL NOT BE MORE THAN 0.02.
12. PAINTING : ONE COAT EACH OF ZINC CHROMATE PRIMER & FINISH SYNTHETIC ENAMEL PAINT OF DA GREY SHADE.

Assistant Engineer/CHP
RGTPP, HPGCL
Khedar (Hisar)

Executive Engineer/CHP
RGTPP, HPGCL
Khedar (Hisar)

Annexure - X

TEST PROCEDURES FOR CONVEYOR IDLERS

WATER PROOF TEST: The waterproof test is carried out in the presence of customer in chamber. Water tests at a pressure of 1 Kg/ Cm² shall be impinging at 45 deg, on both side of bearing housing and idlers roller shall be run at more than the actual working speed encountered at site. Each idler roller shall be tested for water test for 4 hrs. After the test the idler roller shall be dismantled and bearing shall be checked for water contamination. There should not be any droplets/ moisture observed inside the bearing area and the grease colour should not change in such a way which is attributed to the water contamination or soap formation.

DUST PROOF TEST: The dust proof test is carried out in the presence of customer representative in dust chamber. The idler roll shall be run continuously for 4 hours at more than the actual working speed encountered at site. The coal dust shall be continuously agitated and continuous cloud of dust to be maintained always. Grain size of coal dust shall not exceed 38 microns. Check for grain size of coal dust to be witnessed by customer. There should not be any dust contamination observed in the grease by visual / hand feeling.

FRICION FACTOR TEST: Idlers will be rotated to 100 -125% normal running RPM. The speed will be checked by a Photo Electric Tachometer. Rotating source will be removed and stopwatch put into operation. Due to friction, the idler shallowly comes to rest and the period of rotation up to rest is noted in the stopwatch. From the formula for friction, the friction factor is calculated. Friction factor check with Dynamic friction test to be witnessed by Customer as per formula enclosed.

Friction Factor = 0.02 Max

Calculation for Friction Factor: $F = [(d_1^2 + d_2^2) / 16] \times [(2\pi n) / 60] \times [1 / t] \times [2 / d_1] \times [1 / g]$

Where: F = Dynamic friction factor, d₁ = O/D of Roller in Meter, d₂ = I/D of Roller in Meter, n = RPM of Roller (Initial), t = Time of dying down to zero (in Sec.), π=22/7 & g = 9.81 M/ Sec²

Assistant Engineer/CHP
RGTPP, HPGCL
Kheddar (Hisar)

Executive Engineer/CHP
RGTPP, HPGCL
Kheddar (Hisar)

(The bidder must upload this Annexure-II dully signed & stamped along with NIT documents)

STATEMENTS OF BIDDERS

1. Name of Bidder _____
2. Address of Head Office _____
3. Correspondence Address _____

4. Legal status
5. PAN & TIN Number of the Bidder (attached self attested photocopies)
PAN _____ TIN _____

GST No.: _____.
6. Bank Details (attached signed cancelled cheque)
 - i) Bank Name & Address
 - ii) Bank Account Number
 - iii) Bank Branch Code
 - iv) IFSC Code of Branch
 - v) Nature of account (current/saving/OD/CC)
7. Main lines of Business
 - i. _____ since _____
 - ii. _____ since _____
 - iii. _____ since _____
8. Annual Turnover of past three year
 - i. _____
 - ii. _____
 - iii. _____
9. Past Experience:-

Name of Organization	Period	Reference of Contract	Order Value contract wise

10. Any other

Signature & Stamp of Bidder

ANNEXURE-'3' to Schedule-'C'

Special Benefits / Concessions to the Haryana based Micro, Small and Medium Industrial Enterprises in the State Public Procurement as under(G.O. No.- 2/2/2016-41B11 (1) dated 20.10.2016) :-

A. Concessions / Benefits to Micro and Small Enterprises only Haryana based (MSEs):-

Sr. No.	Area as part of qualifying requirements	Concessions / benefits allowed to MSEs	Eligibility
1	Tender Fee	Exemption on the payment of tender fee subjected to fulfillment of conditions as per eligibility	<p>Manufacturing Micro & Small Enterprises(MSEs) (Including Khadi & village Industries/Units) who have filed Entrepreneur Memorandum in Haryana in respect of the quoted items, participate directly in tender and not through any intermediaries (their dealers/agent/distributors), will not subcontract to any other firm and to carry the entire manufacturing at their enterprise.</p> <p>Concerned MSE will be required to submit the copy of Entrepreneurs Memorandum in respect of its category of Micro/small issued to the firm by the Industries Department Haryana as part of Technical Bid.</p> <p>Manufacturing Micro & Small Enterprises(MSEs) (Including Khadi & village Industries/Units) who have filled Entrepreneur Memorandum in Haryana and further:-</p> <p>a) Those MSEs have Quality Certification of ISI/ ISO / AgMark/ Quality Mark issued from competent authority in State or Central Govt. in respect of the items/ goods mentioned in the tender.</p> <p align="center">OR/AND</p> <p>b) Those who were registered with DGS&D/NSI / GOI Department/ State Govt. Department / GOI PSUs/ State Govt. PSUs in respect of the item/ goods mentioned in the tender.</p> <p>The firm will be required to submit the detailed information in respect of above through an affidavit as per the format enclosed as Annexure-D-I</p>
2	Earnest Money Deposit (EMD)	Exemption on the payment of Earnest Money Deposit (EMD) subjected to fulfillment of conditions as per eligibility	
3	Performance Security	90% concession on performance security as applicable to other Haryana based firm's subject to fulfillment of condition as per eligibility.	
4	Turnover	<p>a) Micro Enterprises: Concession of 80% on turnover condition imposed as qualifying criteria.</p> <p>b) Small Enterprises: Concession of 70% on turnover condition imposed as qualifying criteria</p>	
5	Past performance & Experience	Exempted in respect of Past Performance & Experience as part of requirements of the tender subject to fulfillment of conditions as per eligibility.	
6	Purchase Preference	50% of the total tendered quantity providing quoting price within band of L-I+15% by bringing down their price to L-I and subject to condition that it agrees to fulfillment of other terms & conditions of the tender and further subject to fulfillment to conditions as per eligibility.	

B. Concessions / benefits to Medium Enterprises:-

Sr. No.	Area as part of requirements	Concessions benefits allowed to MSEs	Eligibility
1	Past Performance & Experience	Exemption on requirements of Past Performance & Experience as part of qualifying requirements of the tender subject to fulfillment of conditions as per eligibility.	<p>Manufacturing Medium Enterprises of the state have filled Entrepreneur Memorandum for quoted items in Haryana, participated directly in tender and not through any intermediaries (their details/agents distributors), and will not subcontract to any other firm and to carry the entire manufacturing at their enterprises. This concession will be applicable only for one year to newly registered Medium Enterprises or Medium Enterprises of state who are not eligible in State Public Procurement due to eligibility criteria of Past performance & experience. The firm will be required to submit the detailed information in respect to above through an affidavit as per the format enclosed at Annexure-D-II</p>
2	Purchase Preference	10% of the total tendered quantity provided quoting price within band of L-I+15% by bringing down their price to L-I and subject to condition that it agrees to fulfillment of other terms & conditions of the tender and further subject to fulfillment of conditions as per eligibility.	

(Seeking benefits / concessions in past performance / Experience & Purchase Preference by Haryana based manufacturing Micro & Small Enterprises (MSEs) in the state Public Procurement)

(On non Judicial paper of Rs. 10/-)

I _____ S/o _____ aged _____ residing at _____

Proprietor / Partner / Director of M/s _____

do hereby solemnly affirm and declare that:-

1. My / our above noted enterprise M/s _____ (name & Address) _____ has been issued manufacturing Entrepreneurs Memorandum in Haryana by the District Industries Center _____ under acknowledgement No. _____ of dated _____ (Self certified copy of the same is attached as **Annexure-A** with this affidavit) and has been issued for manufacture of the following items in **category Micro / Small Enterprise** (please tick the either) as under:-
 - i) _____
 - ii) _____
 - iii) _____
2. That the quoted item(s) in the tender _____ is one (or more) of the item for which my/our above noted enterprise has been issued. Manufacturing Entrepreneurs Memorandum by the Industry Department Haryana as per details at para 1 above.
3. That my/our above mentioned manufacturing Micro/Small Enterprises fulfills either or both of the below mentioned eligibility criteria:-
 - i. That my/our above mentioned enterprise has been issued quality certification of ISI Mark/ ISO/ Ag.Mark/ any other quality mark _____ (please tick either of the option) by _____ (name of GOI/ State Govt. Agency/ Institution authorized by GOI/ State Govt.) on _____ and the same is valid from _____ to _____ in respect of item/ good (give name of item/ good) _____ mentioned in the tender (Self Certified Copy of the relevant certificate is attached as **Annexure A'** with this affidavit).
 - ii. That my/our above mentioned enterprises has been registered with DGS&D, GOI/NSIC/ Govt. of India Departments /State Govt. Department/ Govt. of India Public Sector Undertaking (PSUs) or State Government Public Sector Undertakings (PSUs) (Please tick one of the option as above) in respect of Name of item/ goods/work/services _____ (Name) as mentioned in the tender for the corresponding period of time of this tender. A self Certified Copy of the same attached as Annexure 'B' with this affidavit.
4. That in case the purchase order of the quoted item is issued to me/us, it will not be outsourced or subcontracted to any other firm and the entire manufacturing of the order item shall be done In-house by our Enterprises based in Haryana (address mentioned as at Sr. No.1) Further, the billing will be done from Haryana.

Dated:

DEPONENT

VERIFICATION:

Verified that the contents of para no. 1 to 4 of the above are true and correct to my knowledge as per the official record and nothing has been concealed therein.

Dated:

DEPONENT

(For seeking the benefits / concessions by Haryana based manufacturing Medium Enterprises in Past Performance / Experience & Purchase Preference in the state Public Procurement)

(On non Judicial paper of Rs. 10/-)

I _____ S/o _____ aged _____ residing at

 Proprietor / Partner / Director of M/s _____

do hereby solemnly affirm and declare that:-

1. M/s / our above noted enterprise M/s _____ (name & Complete Address) _____ has been issued manufacturing Entrepreneurs Memorandum in Haryana by the District Industries Center _____ under acknowledgement No. _____ of dated _____ (Self certified copy of the same is attached as **Annexure-A** with this affidavit) and has been issued for manufacture of the following items in **category Medium Enterprise** as under:-
 - i) _____
 - ii) _____
 - iii) _____
 - iv) _____
2. That my/our above mentioned manufacturing Medium Enterprises meet all the remaining terms & conditions of the tender except Past Performance / Past Experience.
3. That my first Purchase order under this benefit / concession was issued by State Government Department / State Government Agency (name of Deptt. / Agency) _____ vide P.O. No. _____ of dated _____ for the supply of _____ (name of the item/good/works/services) was successfully complied by above mentioned Enterprises. A self certified copy of the same is attached as **Annexure-B** with this affidavit.
4. That in case the Purchase Order of the quoted item is issued to me/us, it will not be outsourced or subcontracted to any other firm and the entire manufacturing of the order item shall be done in-house by our enterprise based in Haryana, (address mentioned as at Sr. No.1).
5. That we agree to the condition that this benefit / concession to the Medium Enterprise is valid for one year from the date of getting the first supply order under state Public Procurement.
6. That the billing will be done from Haryana.

Dated:

DEPONENT

VERIFICATION:

Verified that the contents of para no. 1 to 6 of the above are true and correct to my knowledge as per the official record and nothing has been concealed there in.

Dated:

DEPONENT

The general guidelines for the apportionment of tendered quantity to the firms other than MSMEs, MSEs and MEs will be as under:-

- i. Purchase Preference to MSMEs will not be applicable if the tendered quantity is only one.
- ii. Purchase preference for Medium Enterprises (MEs) will only be allowed on the quantities in multiple of 10 say 10, 20, 30 and so on. The quantity less than 10 or in between multiple of 10, 20, 30 will not be considered for Purchase Preference to MEs.
- iii. Negotiations will be held only with L1+5% firms. MSMEs as per above instructions within the price range of L1+15% will be counter offered to match the finally arrived L1 rate. In case MSMEs within L1+15% range refuse to match the finally arrived L1 rate then the entire 60% (50% for MSEs and 10% for MEs) of Purchase Preference will be transferred to L1+5% category firms.
- iv. In case, no micro & Small Enterprises (MSEs) and Medium Enterprises (MEs) as per eligibility criteria specified in the above instructions are within L1+15% range, the entire 100% tendered quantity will be distributed as per the existing guidelines.
- v. In case there are no Micro & Small Enterprises (MSEs) within L1+15% range, the Purchase Preference Quota of 50% of MSEs will stand transferred to open category making it from 40% to 90%
- vi. In case there are no Medium Enterprises (MEs) within L1+15% range, the Purchase Preference Quota of 10% of MEs will stand transferred to open category making it from 40% to 50%
- vii. In case no MSMEs, within L1+5% range and there is one MSE & one ME in L1+15% range and further agree to match the arrived L-1 rate. The quantity will be distribution will be upto 40% for firm other then MSME, upto 50% for MSE and upto 10% for ME and so on.
- viii. In case there are MSMEs (both or either MSEs) within L1-5% range and there are MSEs & MEs in L1+15% range. Negotiations will be carried out with all firms within L1+5% as per existing guidelines to arrive at finally arrived L1 rate. The finally arrived firm can be any other such a situation, apportionment will be done as per the existing instructions of ratio of 70:30 or 50:25:25 & so on. Thereafter, offer will be given to MSE and MEs within L-15% range to match the finally arrived L1 rate and if they agree to match the arrived L-1 rate, the apportionment of quantity will have many scenarios of quantity apportionment may be as per annexure-III enclosed with this notification. However, there can be many more scenarios depending upon the number of MSMEs within price range of L1+5% and L1+15%.

The above instructions will supersede the instructions as issued vide industries & Commerce Department Haryana Order No. 2/2/2010-41-IB-II of dated 24.03.2015 related to concessions / benefits to Haryana based Micro & Small Enterprises (MSEs) including Khadi & Village Industrial Units.

STANDARD OPERATING PROCEDURES TO BE FOLLOWED TO MONITOR GST COMPLIANCE :

Stage I : Floating of Notice Inviting Tender (NIT) - (to be followed by executive wing)

- It is to ensure that the all prospective bidders to submit copy of Registration Certificate under GST Act.
- The following undertakings (on the letter head of bidder) to be made part of mandatory documents to be submitted by all bidders:
 - 1.1. GST registration is valid as on date
 - 1.2. No default has ever been made by bidder in filing the various GST returns and deposit of GST dues with the department.
 - 1.3. Bidders having multiple registrations under GST will submit undertaking for each & every GST number. A default under a GST number even if the GST number pertains to some other state, will make the vendor ineligible to participate in tender.

In addition, the successful bidder will also submit the following undertakings in addition to above immediately after issue of work order and with submission of each & every bill unless mentioned otherwise:

- 1.4. Undertakings mentioned at 1.1, 1.2 and 1.3
- 1.5. A CA certificate regarding validity of GST registration will be submitted every six months during the tenure of contract.
- 1.6. Vendor will submit copies of GSTR I and GSTR 3B/challans as evidence to deposit of GST with certification that GST collected from HPGCL, to be specified in exact rupees, has been paid to Govt. vide this challan (specifying the challan no. & date of deposit) and returns filed (date of filing of return) includes the transaction of supply of Good or/and services to HPGCL.
- 1.7. Vendor will inform immediately the HPGCL about initiation of any proceeding (if any) against him under the GST laws which may result in suspension or cancellation of GST number of the Vendor.
- 1.8. Undertaking to indemnify the HPGCL in case of any financial implication on HPGCL due to non-compliance of prescribed obligation under the GST Law on part of the Supplier/vendor.
- 1.9. In case of ARCs/AMCs having duration above one year, copies of GSTR 1, GSTR 2A and GSTR 3B along with copies of invoices raised to HPGCL, duly reconciled with three returns to be submitted on quarterly basis.

In case of one time job orders and purchase orders, copies of GSTR 1, GSTR 2A and GSTR 3B along with copies of invoices raised to HPGCL, duly reconciled with three returns to be submitted before release of the security.

Stage II : Scrutiny of bids - (to be followed by Bid screening Committee)

- The GST registration status of vendors will be verified from the official website www.gst.gov.in
- The address of vendor, the place from which supplies will be made or the invoice will be raised, mentioned in bid document should match with the GST registration number on the department's website. In case vendor is having multiple GST registration numbers, executive to ensure that GST number linked to place of supplier should be submitted to HPGCL.
- Filing status of following returns is to be verified that the returns are being filed by vendor within due dates:

Return	Periodicity of filing	Return for
GSTR1	Monthly	Outward supplies
GSTR2A	Monthly	Its auto populated on GST portal on the basis of GSTR 1 filed by vendor.
GSTR 3B	Monthly	Payment of GST
GSTR9	Yearly	Compilation of outward and inward supplies, made during the FY
GSTR9C	Yearly	Analytical statement on GST returns certified by GST Auditor

- Verify that the undertakings, as specified in NIT, have been submitted by bidders. Failure to submit unconditional undertakings will render the bidder to ineligible at technical stage of evaluation itself.

Stage III : Award of contract/ Issue of PO & WO- (to be followed by executive wing)

- Purchase order/work order to specify that in case of failure at the end of vendor regarding deposit of tax and in complying with conditions mentioned at stage I & II, HPGCL will have right to recover the GST amount in default

along with interest & penal amount and deposit the same directly with GST department on behalf of vendor to the credit of HPGCL.

- Vendor will undertake to immediately inform the HPGCL about any amendment in the GST certificate and to immediately submit the updated registration certificate.

Stage IV : Receipt of first invoice- (to be followed by Executive and Accounts wing)

- Executive wing to verify that the invoice is in performa as specified under GST laws (Section 31 to 34 of CGST Act read with Rules 46 to 55A of the CGST rules deal with the Tax invoice, Credit notes and debit notes) with correct GST number of HPGCL so that no difficulty is faced by HPGCL while claiming Input Tax Credit of GST due to incorrect GST number and also to reconcile the GST number and address of supplier as per invoice with the GST number & address given in tender documents submitted by vendor and submit the duly verified invoice to accounts wing.
- After the implementation of the E-Invoice w.e.f. 01 Oct 2020 generation of e-invoice from common e-invoice portal for B2B supplies by person having aggregate annual turnover of more than Rs. 500 Crs has been made compulsory. And w.e.f 01.Jan 2021 Generation of E-invoice for GST supplies by person having aggregate turnover of more than Rs. 100 Crs has been made compulsory. And w.e.f 01.04.2021 generation of E-invoice for GST supplies by the person having aggregate turnover of more than Rs. 5 Crs is proposed to made compulsory. The nodal officer/engineer in charge of the contract/appointed officer of the respective plant should demand from the supplier E-Invoice containing the invoice reference number (IRN) and QR code. It is worthwhile to note that any tax invoice including tax credit / Debit note issued by such notified person for B2B supplies without following the e-invoicing procedure shall not be treated as a valid document.
- Obtain a undertaking from the vendor who are not generating e-invoice in following format:

We M/s. having PAN and GSTIN, Registration Numberhereby undertake that our Aggregate Turnover (as per Section 2(6) of Central Goods and Services Tax Act, 2017) for FY 2019-20 does not exceed the prescribed threshold (as on the date of this declaration) for generation a Unique Invoice Registration Number (IRN) and QR code as per the provisions of Central Goods and Services Tax Act, 2017 and rules thereunder ("GST Law"). Further, we also undertake that if the aggregate turnover of M/s. exceeds the current

threshold or revised threshold notified by Government of India at any future date, then we shall issue invoice and credit note in compliance with the required provisions of GST Law. In case of any queries from the any state or centre Goods and Services Tax authorities, M/s.will be solely responsible.

Yours Truly,
For M/s.....

Authorized Signatory Name: Designation:

- Accounts wing to check Arithmetical accuracy, Rate of GST charged & other calculations.
- In case there is difference in value of invoice, due to difference in quantity or quality actually supplied, GST will be applied on revised value of invoice

Stage V : Receipt of IInd & subsequent invoices – (to be followed by Executive and Accounts wing)

- In addition to procedure mentioned in stage IV, following steps to be undertaken
- All undertaking mentioned at stage I to be obtained & verified.
- GSTR 2A should be matched with amount of GST paid. In case, the details are not there in GSTR2A, issue needs to be taken up with vendor and GST consultant of HPGCL.

Others: (to be followed by Executive and Accounts wing)

- EMD and Securities/Bank guarantees taken by HPGCL may be refunded only after payment of GST by vendor/contractor which was charged from HPGCL.
- In case any issue arises wrt failure by the firm in GST compliances, all future payments to be put on hold after having consultation with HPGCL's GST consultant.



STANDARD OPERATING PROCEDURES TO MONITOR COMPLIANCES UNDER TDS PROVISIONS OF INCOME TAX ACT:

Any person making specified payments mentioned under the Income Tax Act are required to deduct TDS at the time of making such specified payment (annexure I). The SOP deals with procedure to be followed when HPGCL deducts the tax while making payment to others and when tax is deducted from payments made to HPGCL.

HPGCL as a deductor of tax :

- Any tax deducted from payment to any person is a liability of HPGCL and the tax is to be deposited invariably on or before the due date as per annexure I by filing challan no. ITNS-281

- Filing of TDS return is mandatory and the return should be filed on or before the due date as per annexure I. The type of return to be filed is as under:

Form	Transaction to be reported
24Q	TDS on salaries
26Q	TDS on all payments except salaries
26QC	TDS on rent

- As per section 196 of Income Tax Act 1961, no deduction of tax shall be made by any person from any sums payable to Govt (State & Central Govt)
- As per Circular No.18/2017, The Central Board of Direct Taxes (the Board) for such entities whose income is unconditionally exempt under Section 10 of the Income-tax Act (the Act) and who are also statutorily not required to file return of income as per Section 139 of the Act, there would be no requirement for tax deduction at source (TDS) from the payments made to them since their income is anyway exempted from tax under the Act.

HPGCL is in receipt of payment net of TDS:

- Payer to submit an undertaking that all the TDS pertaining to HPGCL will be deposited and return of TDS so deposited will be filed, with in due time.
- Staff to monthly monitor the Form 26AS to ensure that the TDS deducted out of payment of HPGCL has been deposited to the PAN of HPGCL.
- In case, TDS deducted is not updated in Form 26As after expiry of due date of filing of TDS return, issue needs to be taken up with the concerned party
- Staff to undertake periodic reconciliation of TDS as per 26AS and TDS as appearing in books.
- TDS so deducted by other party should be claimed in Income Tax Return of that financial year

Specified Payments/ Transaction applicable to TDS

TDS is to be deducted on the specified transaction mentioned under Income tax act. These transactions are given below with their section, limits & rate as per FY 2019-20 i.e. AY 2020-21.

Section	Income Type	Limit	TDS Rate In %
192	Salary Income	As per Basic Exemption limit & deduction	—
193	Interest on securities	Rs. 10,000	10%
193	Interest on debenture	Rs. 5,000	10%
194	Dividend other than listed company	NA	10%
194A	Interest other than on securities by other than Bank/FIs	Rs. 5,000	10%
194H	Commission on brokerage	Rs. 15,000	5%
194I	Rent of Land, Building and Furniture	Rs. 2,40,000	10%
194I	Rent of plant & machinery	Rs. 2,40,000	2%
194IB	Rent	Rs. 50,000 per month	—
194IA	Transfer of immovable property other than agriculture land	Rs. 50 lakh	1%
194C	Payment to contractor /subcontractor (single transaction)	Rs. 30,000	2%
194C	Payment to contractor during the year	Rs. 1,00,000	2%
194J	Professional fees/Technical fees etc.	Rs. 30,000	10%

Due date for payment/depositing TDS/return filed

Date of ending of the quarter of FY	Due date for filling of return
30th June (April – June)	31st July of FY
30th September (July-September)	31st October of FY
31st December (Oct.-Dec.)	31st January of FY
31st March (Jan.-March)	31st May of FY immediately following FY
Months	Due date of TDS payment
April to February	7th of following month
March	30th April

DECLARATION

I, _____ (Designation) of _____ (Name of the Corporation/Company/ Board/ Trust), having PAN - _____ (here in after referred as the Corporation/Company/ Board/ Trust), hereby declare and affirm a under;

- (1) That the Corporation/Company/Board/ Trust is a regular income tax assessee.
- (2) That the Corporation/Company/ Board/ Trust has been filing its return of income tax regularly.
- (3) That the Corporation/Company/ Board/ Trust has filed returns of income tax for the financial years 2018-19 and 2019-20 under the provisions of section 139(1) of the Income Tax Act, 1961 as per details given below;

Assessment Year	Acknowledgement Number	Date of filing

- (4) That the new provisions of Section 206AB/Section 206CCA which require deduction/ collection of tax at source at higher rates are not applicable to our Corporation/Company/ Board/ Trust and hence tax may not be deducted/collected at source at higher rates.

(Deponent)

That whatever stated above in the above stated para(s) are true to my knowledge and belief.

(Deponent)

[Handwritten signature]